

HÄFELE

FURNITURE  
HANDLES  
2019 COLLECTION

HÄFELE  
FURNITURE  
HANDLES  
2019 COLLECTION

— **You do not  
seek inspiration.  
You open  
the door for it.**

— **W**hat inspires you? Shapes and colours. Materials and finishes. Your favourite furniture. The entrance portals of old townhouses. Chopin's Nocturne Es-Dur Opus 9 No. 2 or the old punk record with the beautiful scratches. We find contrasts especially inspiring. It is so rewarding when they suddenly meet. Thick and thin, big and small. Black, white, and colourful. Minimalism and exuberant life. Sweet, sour, salty. Contrasts attract. In surfaces, haptics, transitions.

How do you deal with that? Contrasts want us to play with them. We invite you to do exactly that. With the style worlds by Häfele.

# — Contents

New products:



H1910  
Page 12



H1915  
Page 16



H1920  
Page 20



H1710  
Page 48



H1715  
Page 50



H1720  
Page 52



H1925  
Page 24



H1930  
Page 28



H1935  
Page 32



H1725  
Page 54



H1730  
Page 56



H1735  
Page 58



H1940  
Page 36



H1945  
Page 38



H1950  
Page 42



H1740  
Page 60

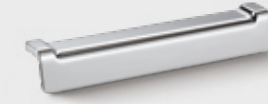

H1745  
Page 61



H1750  
Page 62



H1955  
Page 43



H1960  
Page 44



H1965  
Page 45



H1755  
Page 63



H1760  
Page 64

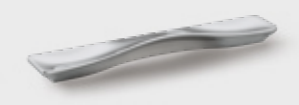

H1765  
Page 65



H1970  
Page 46

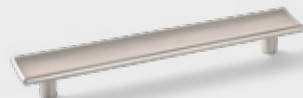

H1975  
Page 47



H1770  
Page 66



H1510  
Page 68



H1515  
Page 69

# — Contents



H1520  
Page 70



H1525  
Page 71



H1530  
Page 72



H1325  
Page 89



H1330  
Page 90



H1335  
Page 92



H1535  
Page 74



H1540  
Page 75



H1545  
Page 76



H1340  
Page 93



H1345  
Page 94



H1350  
Page 95



H1550  
Page 77



H1555  
Page 78



H1560  
Page 79

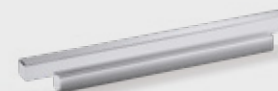

H1355  
Page 96

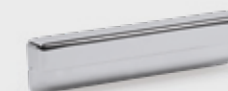

H1360  
Page 97



H365  
Page 98



H1565  
Page 80



H1570  
Page 82

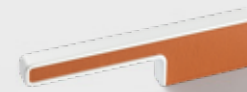

H1575  
Page 84



H1375  
Page 100



H1380  
Page 102



H1385  
Page 104



H1310  
Page 86



H1315  
Page 87



H1320  
Page 88



H1390  
Page 106



H1395  
Page 108

— Our new models show a wide range of ideas that are inspired by worlds of living, zeitgeist and style-defining eras. With textile, we offer a strong line with haptic effects and a cosy appearance as a charming contrast. bent tells a story of craftsmanship and high quality in every detail. A delicate appearance defines the grand entrance of slim. With finesse in the trend of fine lines. nouveau art deco I is, first of all, an eye-catcher, but also a wonderful haptic experience. Stylish reminiscence of a grandiose era. nouveau art deco II brings the pompous side of the 20s to life – a handle as a statement. Pure and simple, in the best sense of the word, the cube fits perfectly into the current trend of the focus on clear function. The cube knobs playfully interpret the cube.

We invite you to get to know our new collection of handles to see and feel. To grasp in both senses of the word. To be inspired.



**textile** — Our home is increasingly becoming a retreat. It should be comfortable and cosy. At the same time, transitions are becoming fluid, multi-functional rooms are in vogue. textile is inspired by the combination of contrasts – technical function and the warm radiance of the unusual feel.



— matt champagne coloured

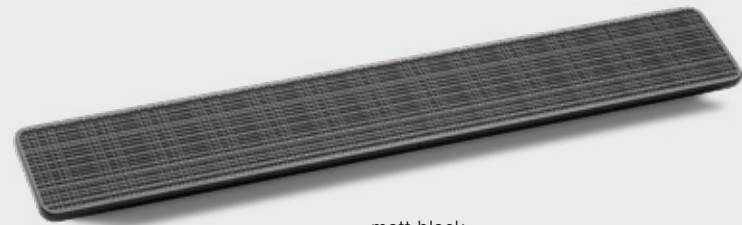

— matt black



— polished brass plated



— antique brass plated

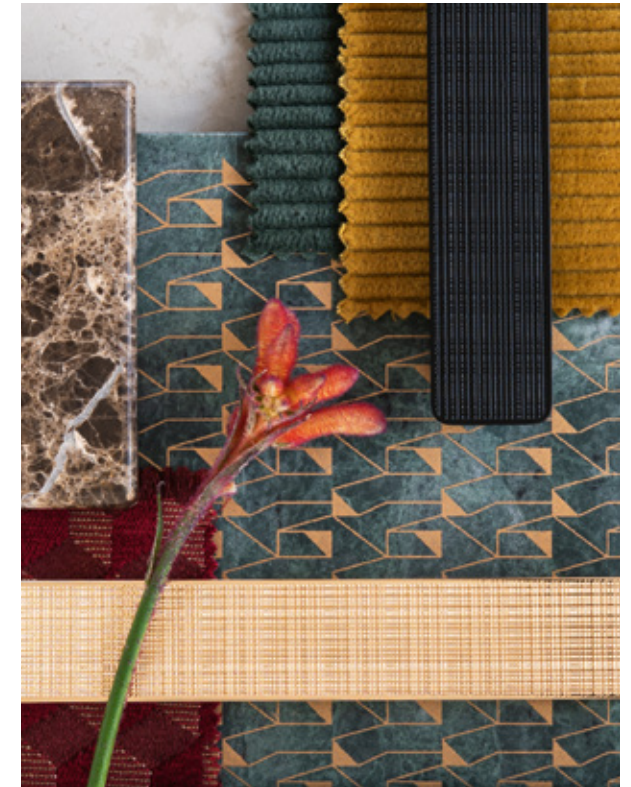

reddot design award  
winner 2019

Finish	Dim. in mm	Hole spacing in mm	Cat. No.
matt champagne coloured	190 x 19	128/160	106.70.000
matt black	190 x 19	128/160	106.70.003
polished brass plated	190 x 19	128/160	106.70.005
antique brass plated	190 x 19	128/160	106.70.006



**bent** — Clarity in the use of forms, top craftsmanship and high quality in every detail. This is what bent represents. An elegant play with shadow and light on its outer contour lends this return to the time of the industrial economic recovery an individual character.

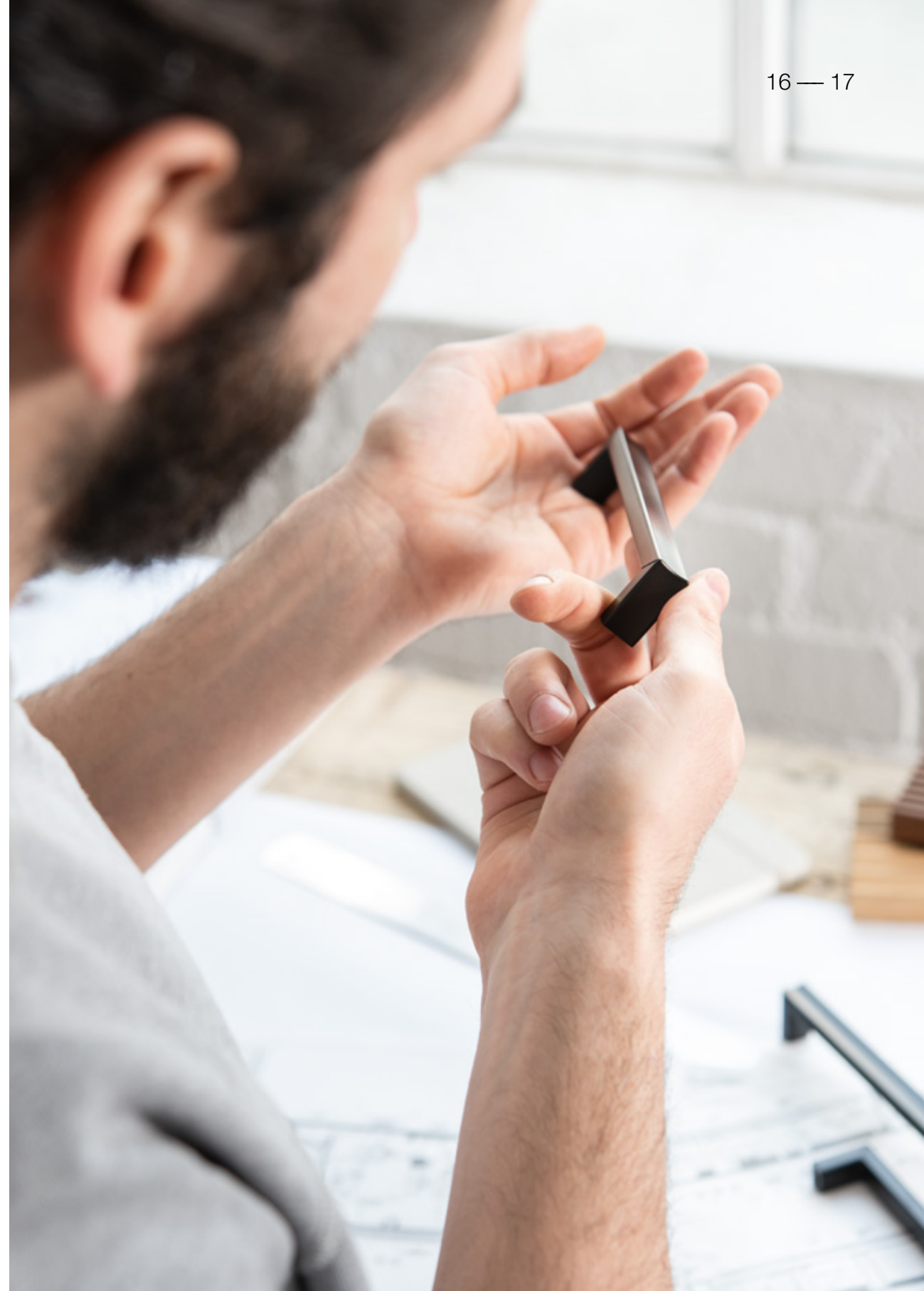



— antique pewter

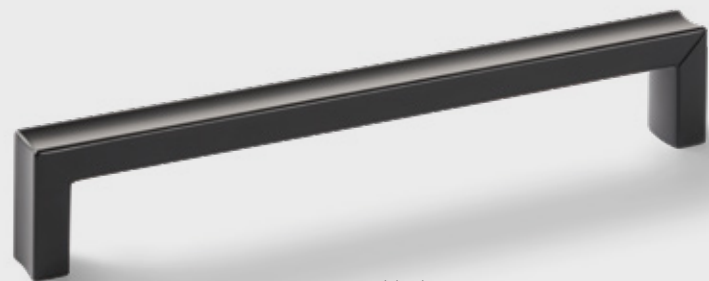

— matt black



— brushed nickel plated



Finish	Dim. in mm	Hole spacing in mm	Cat. No.
antique pewter	169x29	160	106.70.010
matt black	169x29	160	106.70.011
brushed nickel plated	169x29	160	106.70.013



**slim** — Light and delicate, a trend of our time. From the worktop to the sofa frame. Just like slim, the handle featuring thin lines. With its curves, it nestles pleasingly on the furniture piece.

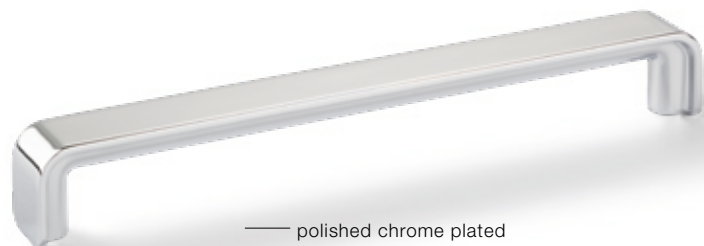

— polished chrome plated

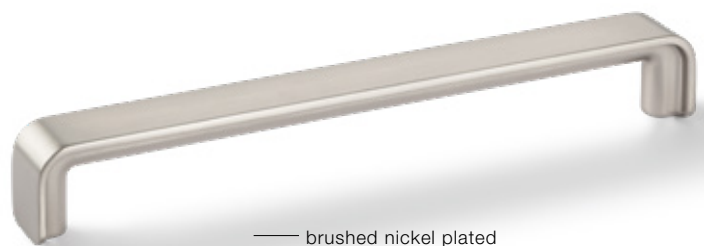

— brushed nickel plated

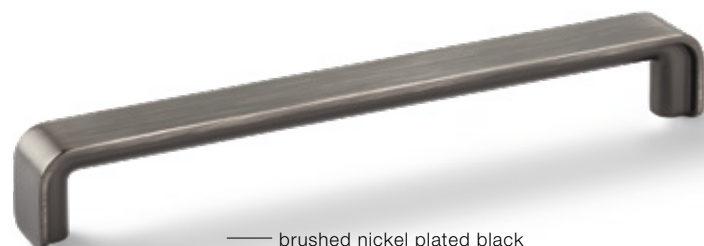

— brushed nickel plated black



— matt black

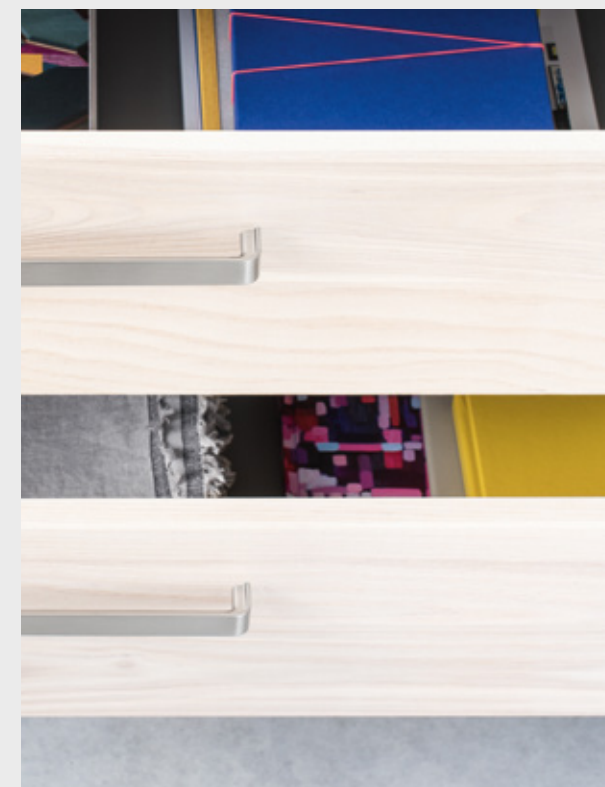

Finish	Dim. in mm	Hole spacing in mm	Cat. No.
polished chrome plated	169x22	160	106.69.460
brushed nickel plated	169x22	160	106.69.461
brushed nickel plated black	169x22	160	106.69.462
matt black	169x22	160	106.69.463

## **nouveau art deco I —**

Its pizzazz and curves reinterpret the wonderful era of Art Deco. Visually, it is a successful reminiscence of this time. Haptically, it's simply an experience. It makes furniture surfaces shine in a new light.



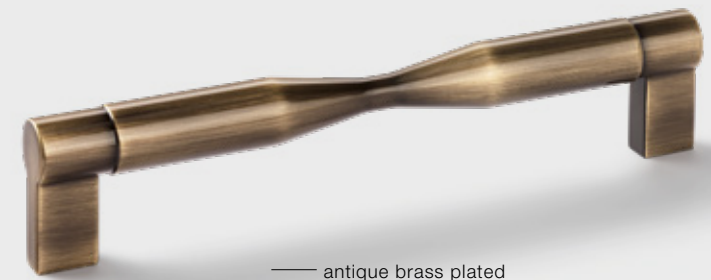
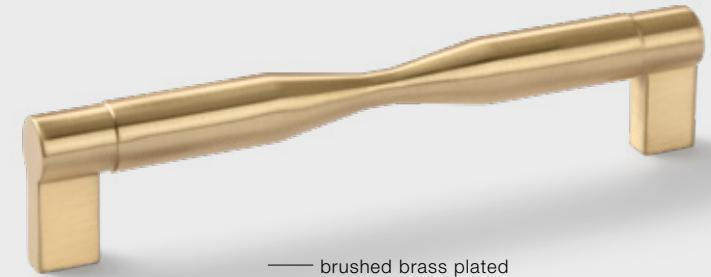

Finish	Dim. in mm	Hole spacing in mm	Cat. No.
brushed brass plated	176x36	160	106.69.402
matt black	176x36	160	106.69.404
antique brass plated	176x36	160	106.69.403

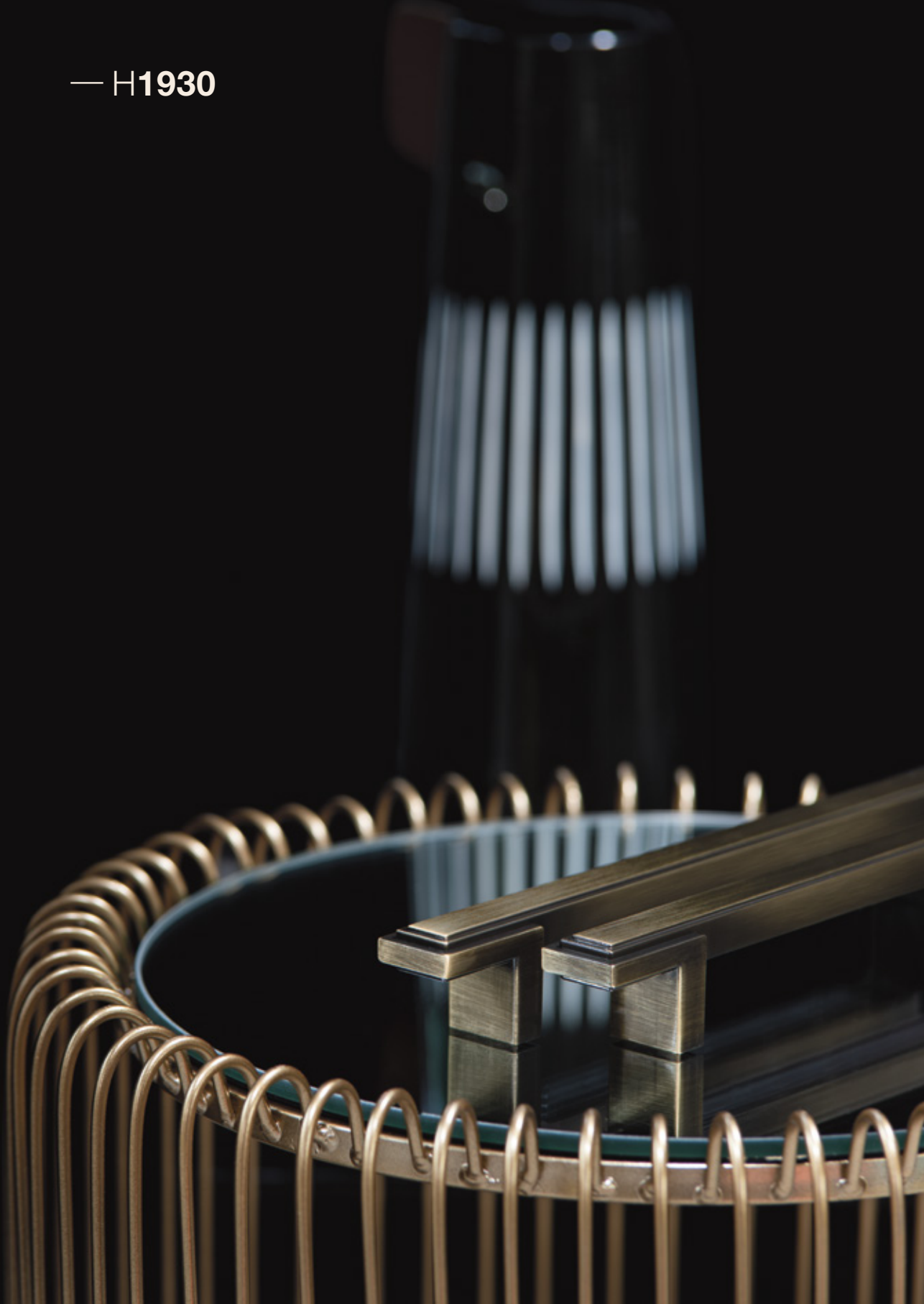

## **nouveau art deco II —**

The glamorous 20's can be reexperienced with this handle. The grand entrance, the elegant interplay of shadow and light. Look, touch – a confident statement that lends your furniture a radiance of Art Deco.

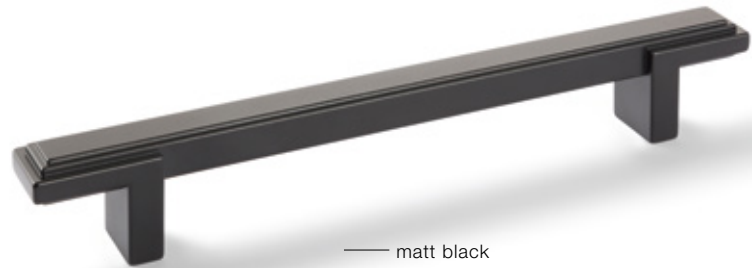

— matt black

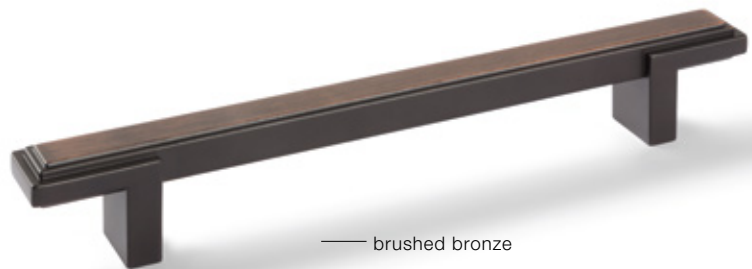

— brushed bronze

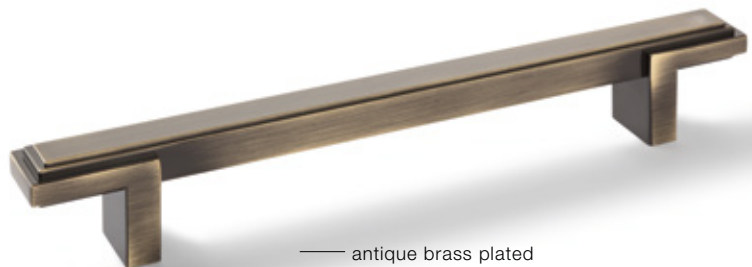

— antique brass plated

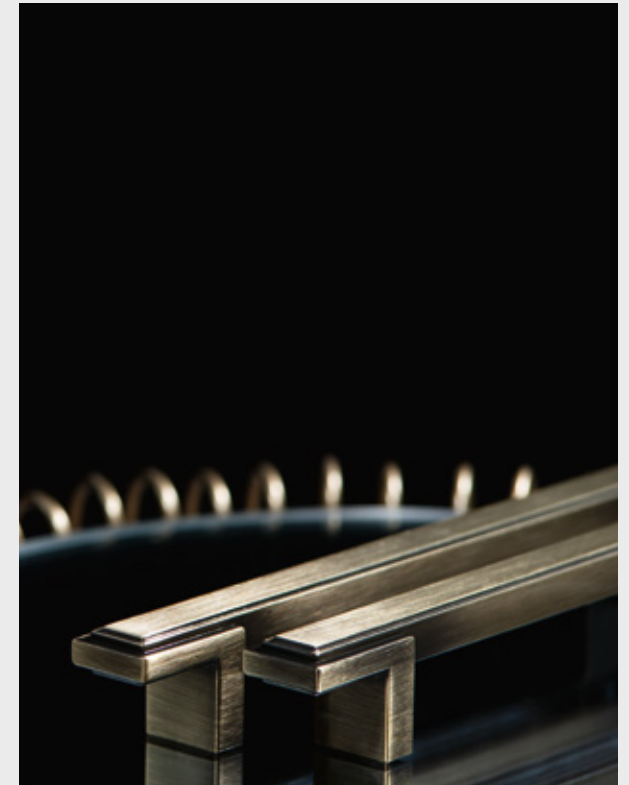

Finish	Dim. in mm	Hole spacing in mm	Cat. No.
matt black	220x30	160	106.69.415
brushed bronze	220x30	160	106.69.414
antique brass plated	220x30	160	106.69.413



**cube** — Open spaces and flexible storage spaces are the solutions of today. They demand simplicity and directness. cube is made precisely for that purpose with its pure and architectural appearance. A handle that fits perfectly into this trend, due to its excellent usability.





Finish	Dim. in mm	Hole spacing in mm	Cat. No.
matt black rough	142x34	128	106.70.060
	174x34	160	106.70.061
	206x34	192	106.70.062
grey	142x34	128	106.70.050
	174x34	160	106.70.051
	206x34	192	106.70.052
black	142x34	128	106.70.040
	174x34	160	106.70.041
	206x34	192	106.70.042
brushed nickel plated	142x34	128	106.70.030
	174x34	160	106.70.031
	206x34	192	106.70.032

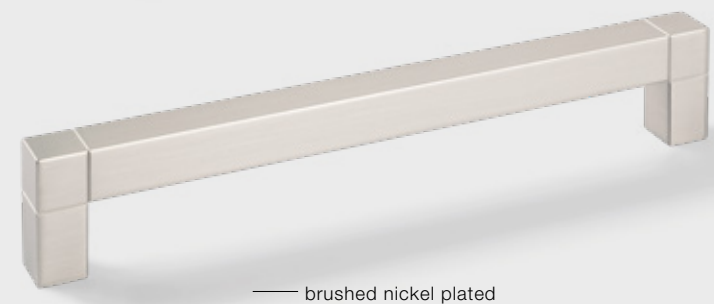
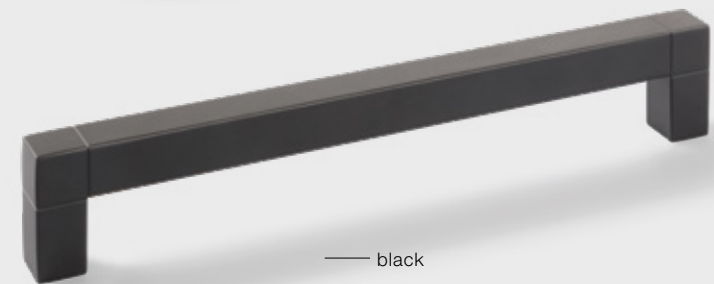
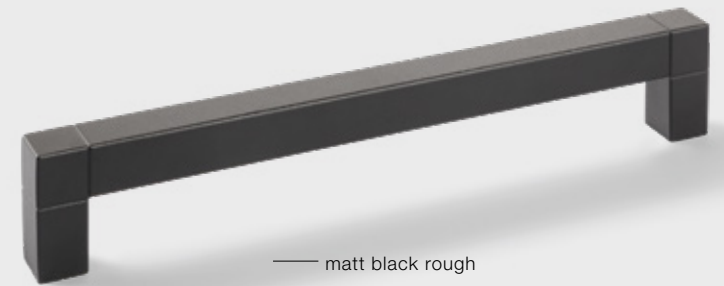



## **cube knobs —**

The playful interpretation of the cube gives the strictly functional appearance an individual touch. cube knobs give every piece of furniture its own independent appearance.

— H1940



— matt black rough



— grey



— black



— brushed nickel plated

— H1945



— matt black rough



— grey



— black



— brushed nickel plated

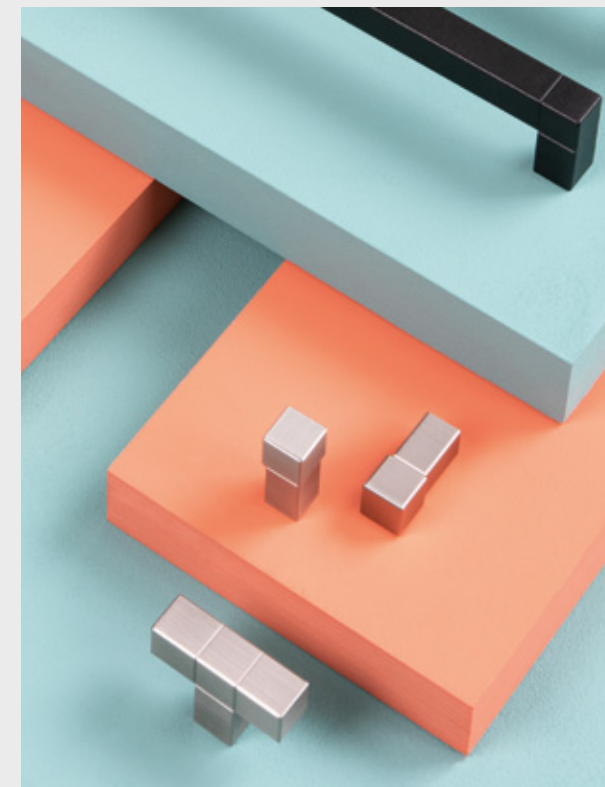

Finish	Dim. in mm	Cat. No.
matt black rough	14 x 34	106.70.074
	46 x 34	106.70.084
grey	14 x 34	106.70.073
	46 x 34	106.70.083
black	14 x 34	106.70.072
	46 x 34	106.70.082
brushed nickel plated	14 x 34	106.70.071
	46 x 34	106.70.081

— If you are caught by inspiration there are influences to discover everywhere, waiting to be transformed into designs.

We are proud of the range of handles over the years – to touch, grab, caress, pull, and push, and as an exciting addition to your designs.



— brushed black used look

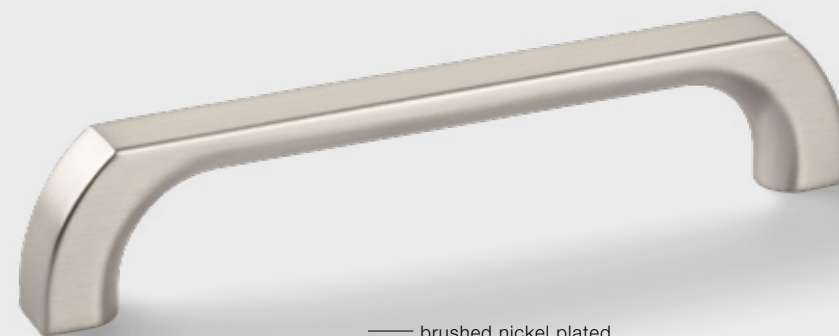

— brushed nickel plated



— brushed nickel plated



— matt black



— silver coloured



— matt chrome plated



— antique pewter

Finish	Dim. in mm	Hole spacing in mm	Cat. No.
brushed black used look	108x26	96	106.69.420
	140x26	128	106.69.421
	172x26	160	106.69.422
	204x26	192	106.69.423
brushed nickel plated	108x26	96	106.69.430
	140x26	128	106.69.431
	172x26	160	106.69.432
	204x26	192	106.69.433
matt black	108x26	96	106.69.440
	140x26	128	106.69.441
	172x26	160	106.69.442
	204x26	192	106.69.443
	204x26	192	106.69.443
silver coloured	108x26	96	106.69.450
	140x26	128	106.69.451
	172x26	160	106.69.452
	204x26	192	106.69.453

Finish	Dim. in mm	Hole spacing in mm	Cat. No.
brushed nickel plated	110x28	96	106.69.470
	142x28	128	106.69.471
	174x28	160	106.69.472
matt chrome plated	110x28	96	106.69.480
	142x28	128	106.69.481
	174x28	160	106.69.482
antique pewter	110x28	96	106.69.490
	142x28	128	106.69.491
	174x28	160	106.69.492

— H1960



— brushed brass plated



— matt black



— polished chrome plated

— H1965



— matt black



— stainless steel coloured

Finish	Dim. in mm	Cat. No.
brushed brass plated	60 x 28	106.69.502
matt black	60 x 28	106.69.501
polished chrome plated	60 x 28	106.69.500

Finish	Dim. in mm	Hole spacing in mm	Cat. No.
matt black	202 x 23	160	106.60.101
stainless steel coloured	202 x 23	160	106.60.100

— H1970



— bronzed and brushed



— antique pewter



— antique brass plated

Finish	Dim. in mm	Hole spacing in mm	Cat. No.
bronzed and brushed	170x25	128/160	106.69.000
antique pewter	170x25	128/160	106.69.001
antique brass plated	170x25	128/160	106.69.002

— H1975

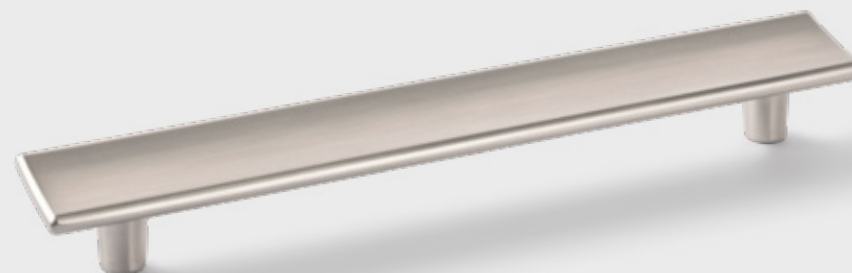

— brushed nickel plated



— matt black



— matt black



— brushed nickel plated black



— brushed nickel plated black

Finish	Dim. in mm	Hole spacing in mm	Cat. No.
brushed nickel plated	200x23	160	106.69.512
	52x23	32	106.69.522
matt black	200x23	160	106.69.510
	52x23	32	106.69.520
brushed nickel plated black	200x23	160	106.69.511
	52x23	32	106.69.521



— H1710  
— new

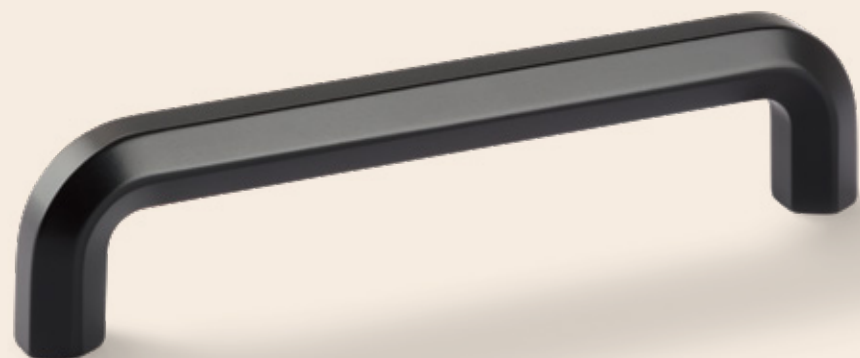

— matt black



— brushed brass plated



— brushed nickel plated black



— antique pewter



— antique copper plated

Finish	Dim. in mm	Hole spacing in mm	Cat. No.
matt black	108x32	96	106.62.304
	140x32	128	106.62.305
	172x32	160	106.62.306
brushed brass plated	108x32	96	106.62.504
	140x32	128	106.62.505
	172x32	160	106.62.506
brushed nickel plated black	108x32	96	106.62.604
	140x32	128	106.62.605
	172x32	160	106.62.606
antique pewter	108x32	96	106.62.904
	140x32	128	106.62.905
	172x32	160	106.62.906
antique copper plated	108x32	96	106.62.004
	140x32	128	106.62.005
	172x32	160	106.62.006

— H1715  
— new



— brushed brass plated



— matt black



— polished chrome plated



— polished copper plated



— antique pewter



— polished nickel plated black



— matt white

Finish	Dim. in mm	Hole spacing in mm	Cat. No.
brushed brass plated	144 x 28	128	106.62.515
	176 x 28	160	106.62.516
matt black	144 x 28	128	106.62.115
	176 x 28	160	106.62.116
polished chrome plated	144 x 28	128	106.62.215
	176 x 28	160	106.62.216
copper plated polished	144 x 28	128	106.62.015
	176 x 28	160	106.62.016
antique pewter	144 x 28	128	106.62.915
	176 x 28	160	106.62.916
polished nickel plated black	144 x 28	128	106.62.315
	176 x 28	160	106.62.316
matt white	144 x 28	128	106.62.715
	176 x 28	160	106.62.716

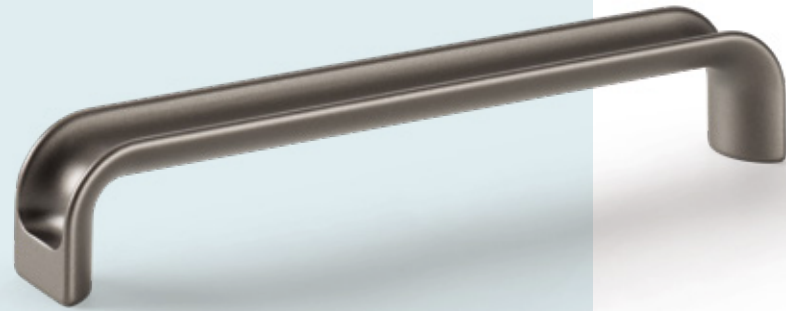

— anthracite coloured

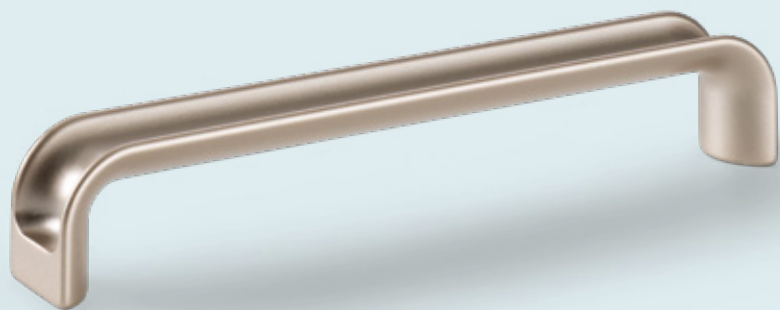

— rosé silver coloured

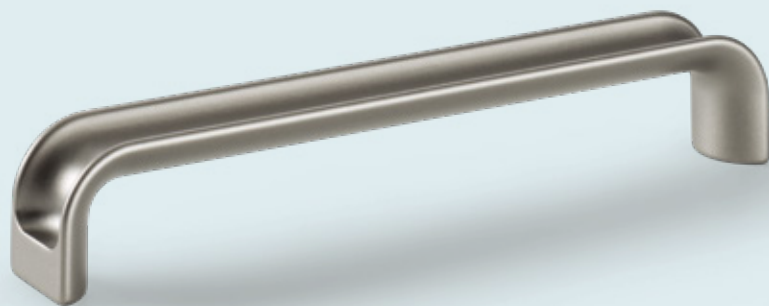

— matt silver coloured



— antique pewter



— matt black

Finish	Dim. in mm	Hole spacing in mm	Cat. No.
anthracite coloured	170x30	160	106.65.446
rosé silver coloured	170x30	160	106.65.746
matt silver coloured	170x30	160	106.65.646
antique pewter	170x30	160	106.65.146
matt black	170x30	160	106.65.346



— anthracite coloured



— rosé silver coloured



— matt silver coloured



— antique pewter



— matt black

Finish	Height in mm	Diameter in mm	Cat. No.
anthracite coloured	30	35	106.65.450
rosé silver coloured	30	35	106.65.750
matt silver coloured	30	35	106.65.650
antique pewter	30	35	106.65.150
matt black	30	35	106.65.350

# — H1730



— brushed nickel plated



— polished chrome plated



— rosé gold coloured



— matt champagne coloured



— anthracite coloured



— matt black

— **H**andles attract hidden harmonies and contrasts of pieces of furniture.

Finish	Dim. in mm	Hole spacing in mm	Cat. No.
brushed nickel plated	180x35	160	106.65.066
polished chrome plated	180x35	160	106.65.266
rosé gold coloured	180x35	160	106.65.866
matt champagne coloured	180x35	160	106.65.566
anthracite coloured	180x35	160	106.65.466
matt black	180x35	160	106.65.366

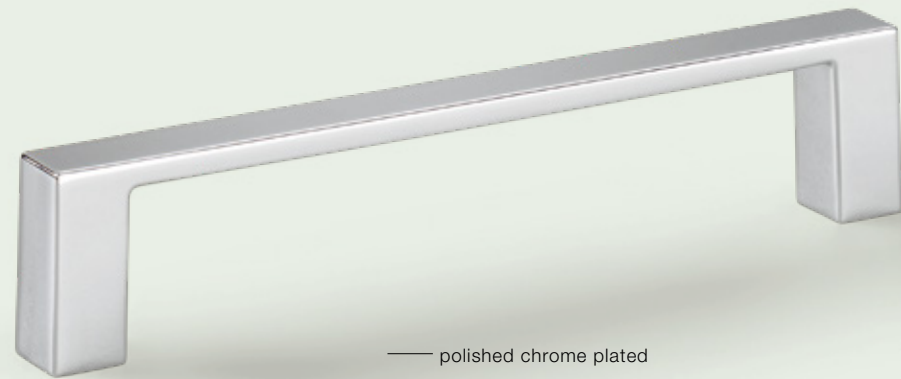

— polished chrome plated



— brushed nickel plated

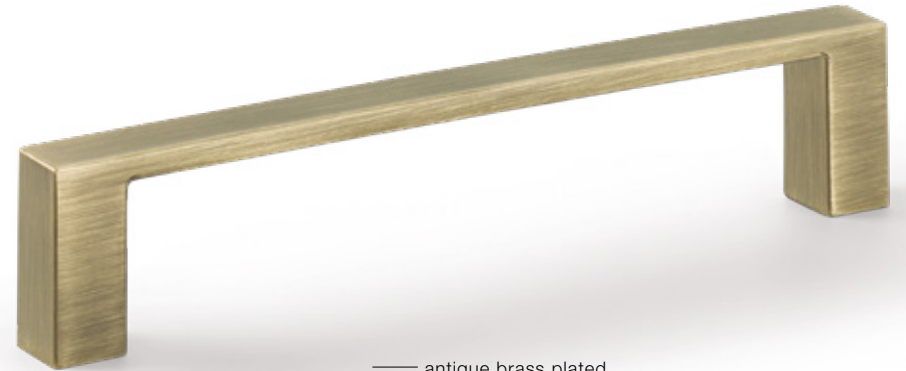

— antique brass plated



— brushed black used look

Finish	Dim. in mm	Hole spacing in mm	Cat. No.
polished chrome plated	139x28	128	106.62.225
	171x28	160	106.62.226
brushed nickel plated	139x28	128	106.62.625
	171x28	160	106.62.626
antique brass plated	139x28	128	106.62.525
	171x28	160	106.62.526
brushed black used look	139x28	128	106.62.425
	171x28	160	106.62.426

— H1740



— brushed nickel plated



— brushed nickel plated black



— matt white

— H1745

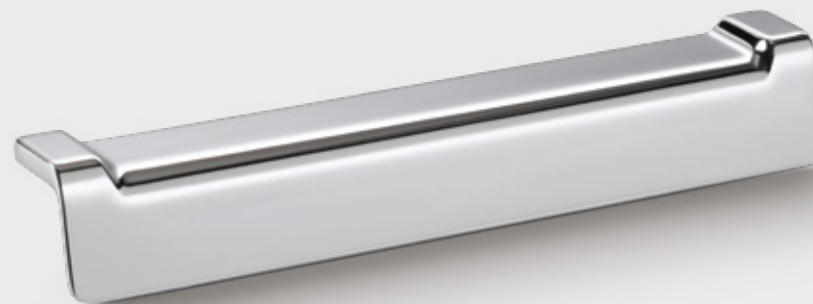

— polished chrome plated



— matt nickel plated



— polished nickel plated black

Finish	Dim. in mm	Hole spacing in mm	Cat. No.
brushed nickel plated	240x35	160	106.62.636
brushed nickel plated black	240x35	160	106.62.336
matt white	240x35	160	106.62.736

Finish	Dim. in mm	Hole spacing in mm	Cat. No.
polished chrome plated	111x26	64	106.62.243
	175x26	96/128	106.62.244
matt nickel plated	111x26	64	106.62.643
	175x26	96/128	106.62.644
polished nickel plated black	111x26	64	106.62.343
	175x26	96/128	106.62.344

— H1750



— polished chrome plated



— brushed nickel plated

Finish	Dim. in mm	Hole spacing in mm	Cat. No.
polished chrome plated	228x39	160/192	106.62.256
brushed nickel plated	228x39	160/192	106.62.656

— H1755



— brushed nickel plated



— polished chrome plated



— brushed nickel plated black



— polished nickel plated black

Finish	Dim. in mm	Hole spacing in mm	Cat. No.
brushed nickel plated	203x32	128/160	106.62.665
polished chrome plated	203x32	128/160	106.62.265
brushed nickel plated black	203x32	128/160	106.62.165
polished nickel plated black	203x32	128/160	106.62.365



— H1760



— matt black

— H1765

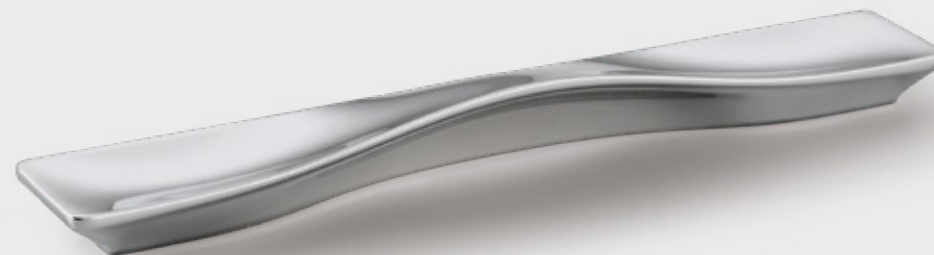

— polished chrome plated



— iron coloured used look



— matt white



— polished nickel plated black

Finish	Dim. in mm	Hole spacing in mm	Cat. No.
matt black	183x48	128	106.62.175
	215x48	160	106.62.176
iron coloured used look	183x48	128	106.62.475
	215x48	160	106.62.476
matt white	183x48	128	106.62.775
	215x48	160	106.62.776

Finish	Dim. in mm	Hole spacing in mm	Cat. No.
polished chrome plated	218x23	160/192	106.62.286
polished nickel plated black	218x23	160/192	106.62.386

# — H1770



— polished chrome plated



— matt nickel plated



— matt black

— **A** handle must emphasise the essence of a piece of furniture.

Finish	Dim. in mm	Hole spacing in mm	Cat. No.
polished chrome plated	172x35	128/160	106.62.295
matt nickel plated	172x35	128/160	106.62.695
matt black	172x35	128/160	106.62.195

— H1510



— polished chrome plated



— brushed nickel plated

— H1515



— polished chrome plated



— brushed nickel plated



— polished nickel plated black

Finish	Dim. in mm	Hole spacing in mm	Cat. No.
polished chrome plated	212x30	160/192	106.61.214
	340x30	288/320	106.61.217
brushed nickel plated	212x30	160/192	106.61.014
	340x30	288/320	106.61.017

Finish	Dim. in mm	Hole spacing in mm	Cat. No.
polished chrome plated	230x27	160/192	106.61.204
brushed nickel plated	230x27	160/192	106.61.004
polished nickel plated black	230x27	160/192	106.61.304

# — H1520

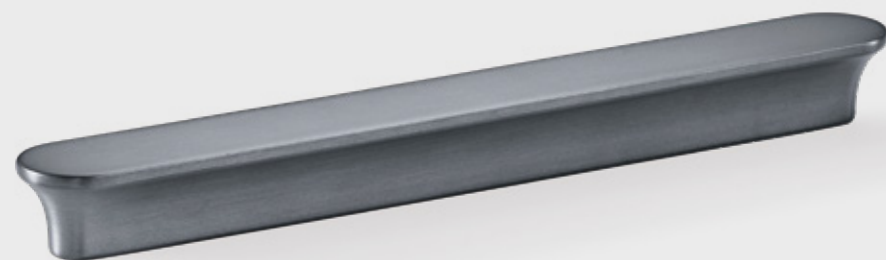

— lead coloured



— titanium coloured



— matt white



— antique copper plated

Finish	Dim. in mm	Hole spacing in mm	Cat. No.
lead coloured	218x21	160/192	106.61.464
titanium coloured	218x21	160/192	106.61.964
matt white	218x21	160/192	106.61.764
antique copper plated	218x21	160/192	106.61.164

# — H1525



— polished chrome plated

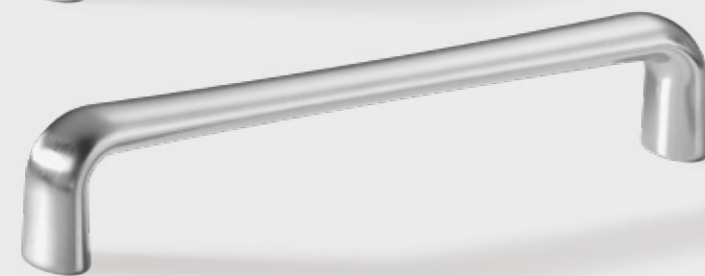

— brushed nickel plated

Finish	Maße in mm	Hole spacing in mm	Cat. No.
polished chrome plated	172x33	160	106.61.254
	332x33	320	106.61.259
brushed nickel plated	172x33	160	106.61.054
	332x33	320	106.61.059
polished nickel plated black	172x33	160	106.61.354
	332x33	320	106.61.359
brushed nickel plated black	172x33	160	106.61.554
	332x33	320	106.61.559
matt bronze	172x33	160	106.61.154
	332x33	320	106.61.159
antique pewter	172x33	160	106.61.954
	332x33	320	106.61.959
antique copper plated	172x33	160	106.61.454
	332x33	320	106.61.459
rosé silver coloured	172x33	160	106.63.716
	332x33	320	106.63.719
rosé gold coloured	172x33	160	106.63.816
	332x33	320	106.63.819

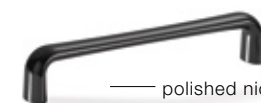

— polished nickel plated black



— brushed nickel plated black



— matt bronze



— antique pewter



— antique copper plated



— rosé silver coloured



— rosé gold coloured



— oil rubbed bronze



— antique pewter



— antique brass plated

Finish	Dim. in mm	Hole spacing in mm	Cat. No.
oil rubbed bronze	148x30	128	106.61.043
	180x30	160	106.61.044
antique pewter	148x30	128	106.61.943
	180x30	160	106.61.944
antique brass plated	148x30	128	106.61.143
	180x30	160	106.61.144

— H1535



— stainless steel coloured



— silver coloured anodized

Finish	Dim. in mm	Hole spacing in mm	Cat. No.
stainless steel coloured	150x50	128	106.60.033
	182x50	160	106.60.034
	214x50	192	106.60.036
silver coloured anodized	150x50	128	106.60.933
	182x50	160	106.60.934
	214x50	192	106.60.936

— H1540

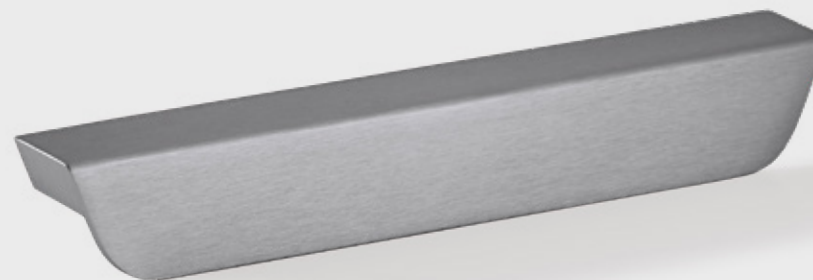

— stainless steel coloured



— silver coloured anodized

Finish	Dim. in mm	Hole spacing in mm	Cat. No.
stainless steel coloured	69x25	32	106.60.041
	197x25	160	106.60.044
silver coloured anodized	69x25	32	106.60.941
	197x25	160	106.60.944

— H1545

— H1550



— stainless steel coloured

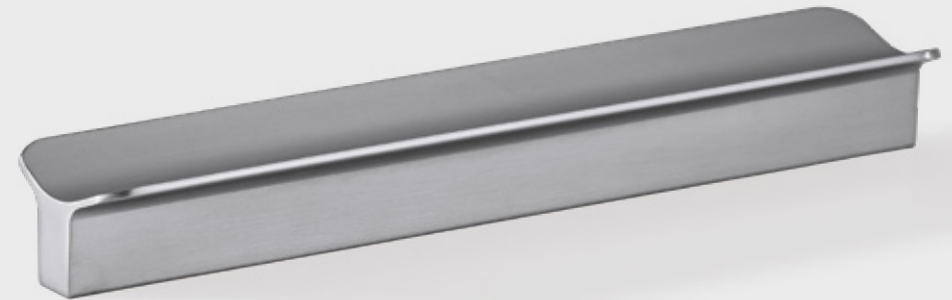

— brushed nickel plated



— stainless steel coloured



— brushed nickel plated

Finish	Dim. in mm	Hole spacing in mm	Cat. No.
stainless steel coloured	200x34	128/160	106.60.023
stainless steel coloured	350x34	256/320	106.60.027

Finish	Dim. in mm	Hole spacing in mm	Cat. No.
brushed nickel plated	44x25	32	106.61.071
	204x25	160/192	106.61.074

— H1555



— polished chrome plated

— H1560

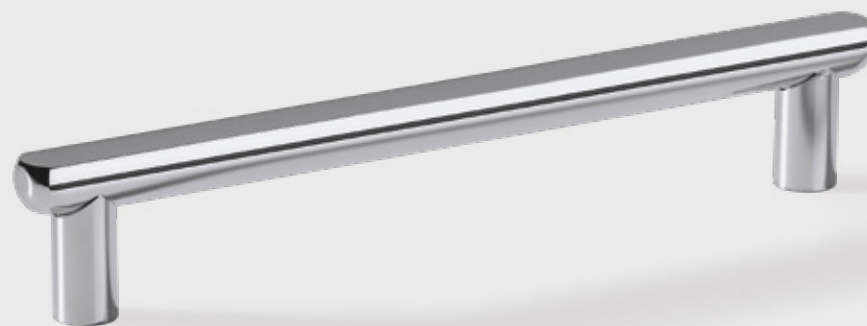

— polished chrome plated



— stainless steel coloured



— stainless steel coloured



— champagne coloured

Finish	Dim. in mm	Hole spacing in mm	Cat. No.
polished chrome plated	312 x 34	192	106.60.205
	440 x 34	320	106.60.208
stainless steel coloured	312 x 34	192	106.60.005
	440 x 34	320	106.60.008
	568 x 34	448	106.60.009

Finish	Dim. in mm	Hole spacing in mm	Cat. No.
polished chrome plated	186 x 31	160	106.60.214
	218 x 31	192	106.60.216
	346 x 31	320	106.60.218
stainless steel coloured	186 x 31	160	106.60.014
	218 x 31	192	106.60.016
	346 x 31	320	106.60.018
champagne coloured	186 x 31	160	106.60.614
	218 x 31	192	106.60.616
	346 x 31	320	106.60.618



# — H1565



— polished chrome plated



— brushed nickel plated black



— oil rubbed bronze

— **W**ithout contrasts, there is no friction, no discourse, no surprising combinations.

Finish	Dim. in mm	Hole spacing in mm	Cat. No.
polished chrome plated	144x32	128	106.61.223
	176x32	160	106.61.224
brushed nickel plated black	144x32	128	106.61.323
	176x32	160	106.61.324
oil rubbed bronze	144x32	128	106.61.123
	176x32	160	106.61.124



— antique pewter



— antique copper plated

Finish	Dim. in mm	Hole spacing in mm	Cat. No.
antique pewter	138x30	128	106.61.933
	170x30	160	106.61.934
antique copper plated	138x30	128	106.61.033
	170x30	160	106.61.034



— Handle: Zinc alloy / Inset: imitation leather



— Handle: Zinc alloy / Inset: imitation leather

Finish	Dim. in mm	Hole spacing in mm	Cat. No.
Handle: white lacquered Inset: cognac coloured	150x33	32	103.83.751
	64x28	32	103.83.761
Handle: lacquered titanium coloured Inset: black/croc leather effect	150x33	32	103.83.051
	64x28	32	103.83.061

— H1310



— matt black

— H1315



— polished chrome plated



— matt white



— brushed nickel plated



— polished chrome plated



— brushed nickel plated



— polished nickel plated black

Finish	Dim. in mm	Hole spacing in mm	Cat. No.
matt black	170x28	160	110.34.306
	202x28	192	110.34.307
matt white	170x28	160	110.34.706
	202x28	192	110.34.707
brushed nickel plated	170x28	160	110.34.606
	202x28	192	110.34.607
polished chrome plated	170x28	160	110.34.206
	202x28	192	110.34.207

Finish	Dim. in mm	Hole spacing in mm	Cat. No.
polished chrome plated	196x30	160	110.34.216
	228x30	192	110.34.217
brushed nickel plated	196x30	160	110.34.616
	228x30	192	110.34.617
polished nickel plated black	196x30	160	110.34.346
	228x30	192	110.34.347

— H1320



— polished chrome plated



— polished chrome plated

— titanium coloured

— brushed nickel plated

Finish	Dim. in mm	Hole spacing in mm	Cat. No.
polished chrome plated	40x24	32	110.34.271
	104x24	96	110.34.274
	199x24	192	110.34.277
	263x24	256	110.34.279
titanium coloured	40x24	32	110.34.071
	104x24	96	110.34.074
	199x24	192	110.34.077
	263x24	256	110.34.079
brushed nickel plated	40x24	32	110.34.671
	104x24	96	110.34.674
	199x24	192	110.34.677
	263x24	256	110.34.679

— H1325



— polished chrome plated



— brushed nickel plated

— matt white

— matt black

Finish	Dim. in mm	Hole spacing in mm	Cat. No.
polished chrome plated	180x28	160	110.34.286
	212x28	192	110.34.287
brushed nickel plated	180x28	160	110.34.686
	212x28	192	110.34.687
matt white	180x28	160	110.34.786
	212x28	192	110.34.787
matt black	180x28	160	110.34.386
	212x28	192	110.34.387



— polished chrome plated



— brushed nickel plated

Finish	Dim. in mm	Hole spacing in mm	Cat. No.
polished chrome plated	172x34	160	106.69.276
	204x34	192	106.69.277
brushed nickel plated	172x34	160	106.69.676
	204x34	192	106.69.677

— H1335

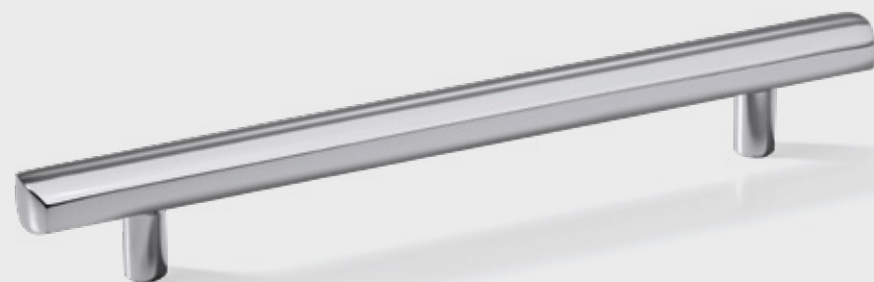

— polished chrome plated



— brushed nickel plated

— matt white

— matt black

Finish	Dim. in mm	Hole spacing in mm	Cat. No.
polished chrome plated	220x30	160	110.35.276
	380x30	320	110.35.279
brushed nickel plated	220x30	160	110.35.676
	380x30	320	110.35.679
matt white	220x30	160	110.35.776
	380x30	320	110.35.779
matt black	220x30	160	110.35.376
	380x30	320	110.35.379

— H1340



— polished chrome plated



— brushed nickel plated



— matt white



— matt black



— polished nickel plated black



— iron coloured used look



— aluminium coloured matt white

Finish	Height in mm	Diameter in mm	Cat. No.
polished chrome plated	31	20	110.35.271
brushed nickel plated	31	20	110.35.671
matt white	31	20	110.35.771
matt black	31	20	110.35.371
polished nickel plated black	31	20	110.35.340
iron coloured used look	31	20	110.35.040
aluminium coloured matt white	31	20	110.35.640

— H1345



— polished chrome plated



— brushed nickel plated



— matt white



— matt black

Finish	Dim. in mm	Hole spacing in mm	Cat. No.
polished chrome plated	215 x 30	160/192	110.34.227
brushed nickel plated	215 x 30	160/192	110.34.627
matt white	215 x 30	160/192	110.34.328
matt black	215 x 30	160/192	110.34.327

— H1350



— polished chrome plated



— brushed nickel plated



— matt white



— matt black

Finish	Dim. in mm	Hole spacing in mm	Cat. No.
polished chrome plated	180 x 26	128/160	110.34.236
	244 x 26	192/224	110.34.238
brushed nickel plated	180 x 26	128/160	110.34.636
	244 x 26	192/224	110.34.638
matt white	180 x 26	128/160	110.34.337
	244 x 26	192/224	110.34.339
matt black	180 x 26	128/160	110.34.336
	244 x 26	192/224	110.34.338



— H1355



— polished chrome plated

— H1360

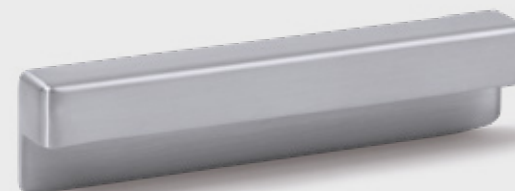

— brushed nickel plated



— stainless steel coloured



— iron coloured used look

Finish	Dim. in mm	Hole spacing in mm	Cat. No.
polished chrome plated	80x24	32	110.35.281
	220x24	128/160	110.35.286
stainless steel coloured	80x24	32	110.35.681
	220x24	128/160	110.35.686

Finish	Dim. in mm	Hole spacing in mm	Cat. No.
brushed nickel plated	42x40	32	110.34.691
	106x40	96	110.34.694
	170x40	160	110.34.696
iron coloured used look	42x40	32	110.34.091
	106x40	96	110.34.094
	170x40	160	110.34.096

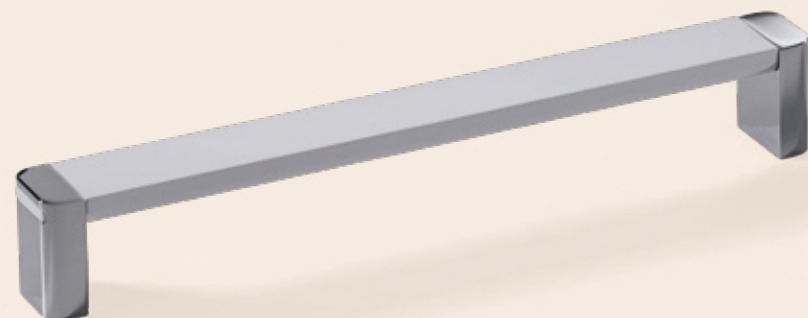

— polished chrome plated, white

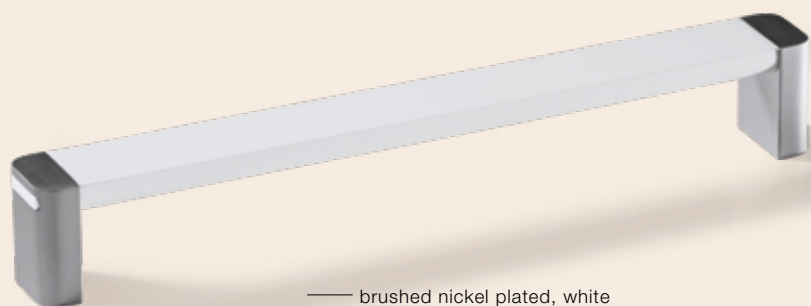

— brushed nickel plated, white



— brushed nickel plated, black



— polished chrome plated, black

Finish	Dim. in mm	Hole spacing in mm	Cat. No.
polished chrome plated, white	202 x 30	192	106.69.217
brushed nickel plated, white	202 x 30	192	106.69.617
brushed nickel plated, black	202 x 30	192	106.69.627
polished chrome plated, black	202 x 30	192	106.69.227



— polished chrome plated



— brushed nickel plated

Finish	Dim. in mm	Hole spacing in mm	Cat. No.
polished chrome plated	227 x 35	192	106.69.267
	355 x 35	320	106.69.268
brushed nickel plated	227 x 35	192	106.69.667
	355 x 35	320	106.69.668

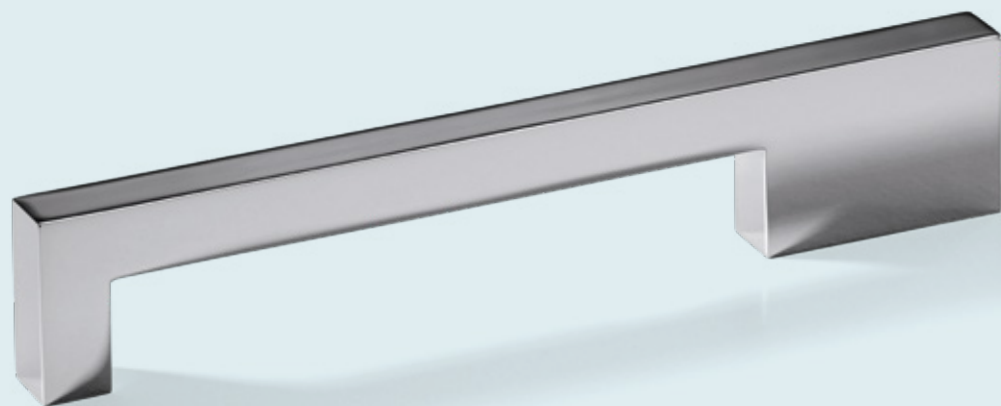

— polished chrome plated



— brushed nickel plated



— matt white



— matt black



— iron coloured used look



— aluminium coloured matt white

Finish	Dim. in mm	Hole spacing in mm	Cat. No.
polished chrome plated	172x32	128/160	110.34.255
	204x32	160/192	110.34.257
brushed nickel plated	172x32	128/160	110.34.655
	204x32	160/192	110.34.657
matt white	172x32	128/160	110.34.356
	204x32	160/192	110.34.358
matt black	172x32	128/160	110.34.355
	204x32	160/192	110.34.357
iron coloured used look	172x32	128/160	110.35.020
aluminium coloured matt white	172x32	128/160	110.35.620

# — H1385

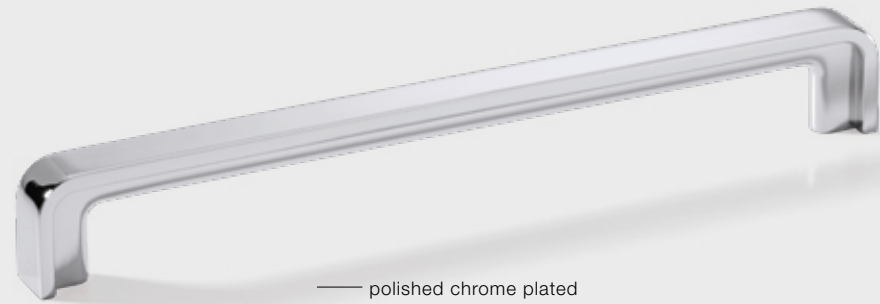

— polished chrome plated



— brushed nickel plated

Finish	Dim. in mm	Hole spacing in mm	Cat. No.
polished chrome plated	146x28	128	110.34.265
	178x28	160	110.34.266
	210x28	192	110.34.267
brushed nickel plated	146x28	128	110.34.665
	178x28	160	110.34.666
	210x28	192	110.34.667

— **G**reat is the power of ideas.  
A better idea can sweep weeks  
of effort off the table.

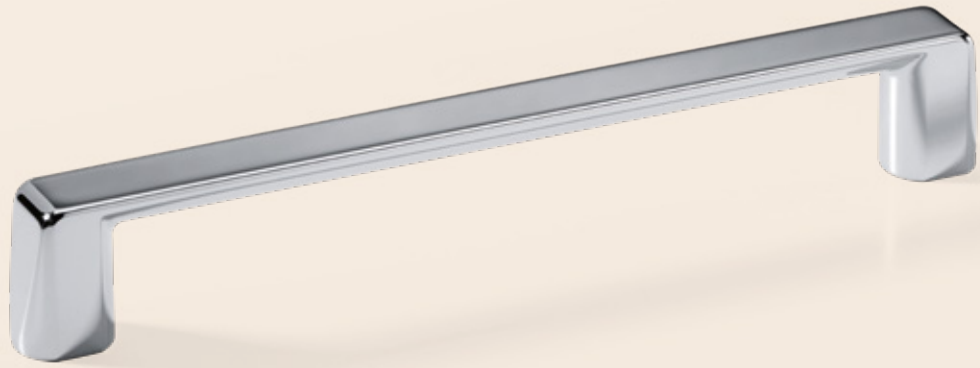

— polished chrome plated



— brushed nickel plated

Finish	Dim. in mm	Hole spacing in mm	Cat. No.
polished chrome plated	148x32	128	106.69.205
	212x32	192	106.69.207
brushed nickel plated	148x32	128	106.69.605
	212x32	192	106.69.607

# — H1395

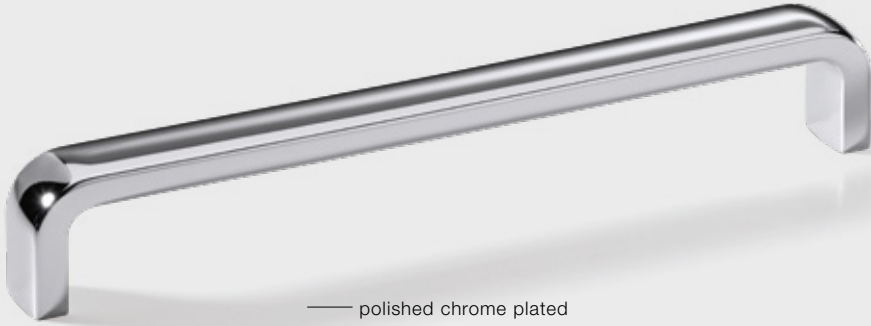

Finish	Dim. in mm	Hole spacing in mm	Cat. No.
polished chrome plated	201 x 32	192	106.69.237
brushed nickel plated	201 x 32	192	106.69.637

**HÄFELE**

[www.hafele.com](http://www.hafele.com)