



Digital door lock Model PP9000



PP9000

Installation guide

Contents

Product specification.....	2
Components.....	3
Prepare for installation.....	4
Installation.....	5

✓ Product specifications

Outside panel

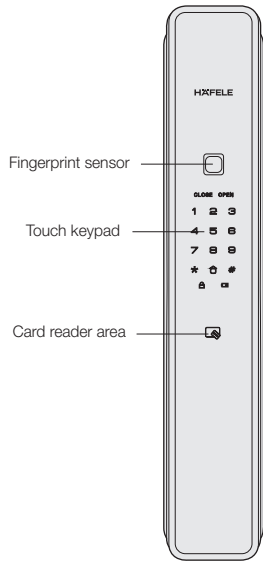

Fingerprint sensor
Touch keypad
Card reader area

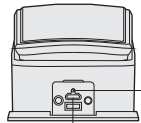

Emergency power port

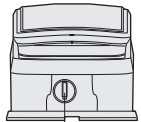

Key cylinder

Inside panel

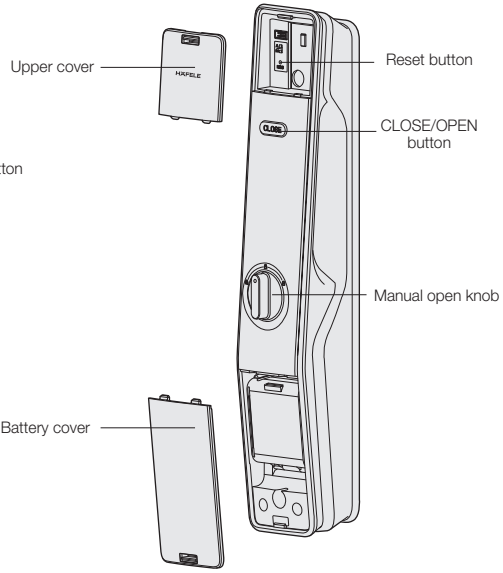

Upper cover
Reset button
CLOSE/OPEN button
Manual open knob

Battery cover

Mortise Lock

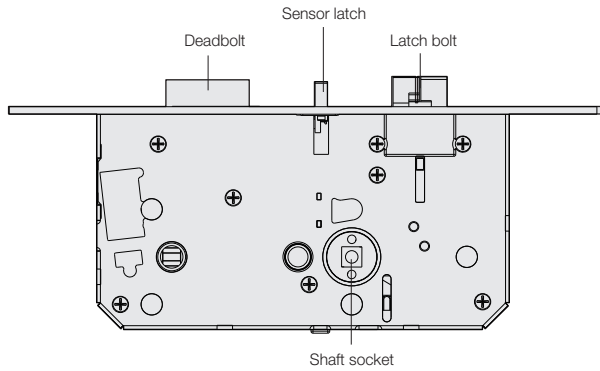

Deadbolt
Sensor latch
Latch bolt
Shaft socket

✓ Components

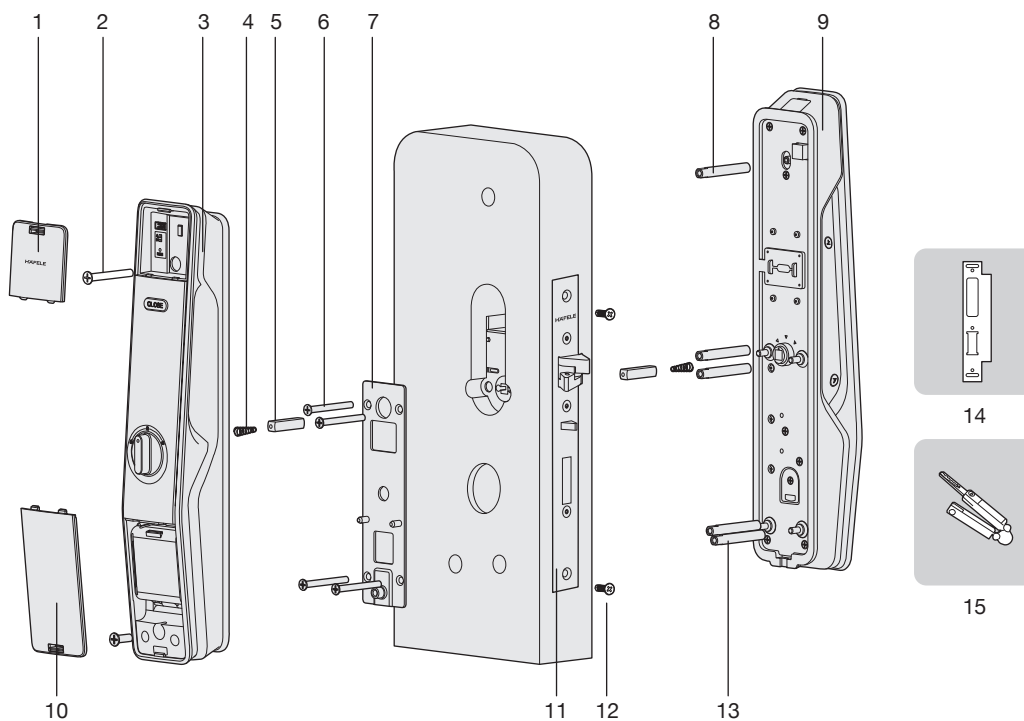

1. Upper cover (1 pc)

2. M6 Mounting screw (2 pcs)

3. Inside panel assembly (1pc)

4. Pressure spring (2 pcs)

5. Square shaft (2 pcs)

6. M5 Mounting plate screw (4 pcs)

7. Mounting plate (1 pc)

8. M6 Connecting screw bolt (1 pc)

9. Outside panel assembly (1 pc)

10. Battery cover (1 pc)

11. Mortise lock (1 pc)

12. Mortise mounting screw (2 pcs)

13. M5 Connecting screw bolt (4 pcs)

14. Strike assembly

-Left strike plate (1 pc)

-Right strike plate (1 pc)

-Strike box (1 pc)

15. Mechanical key (2 pcs)

✓ Preparing for installation

Check door open direction

This product fits for all door open directions-Left-in/Left-out/Right-in/Right-out

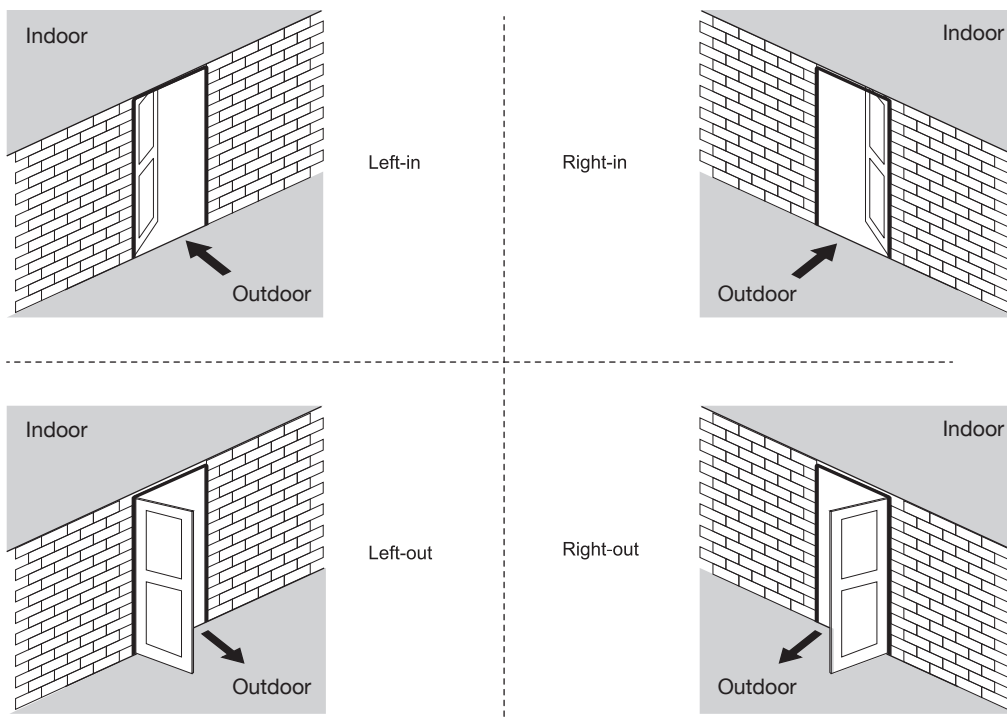

✓ Installation

1. Mark and drill bores by using the installation template first, then fix the mortise into the door frame and tighten the 2 screws to fix the mortise on the door.

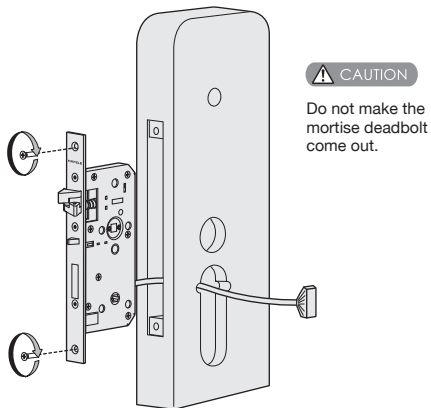

2. Fix 5 screw bolts on the front panel, place square shaft and pressure spring into the bore.

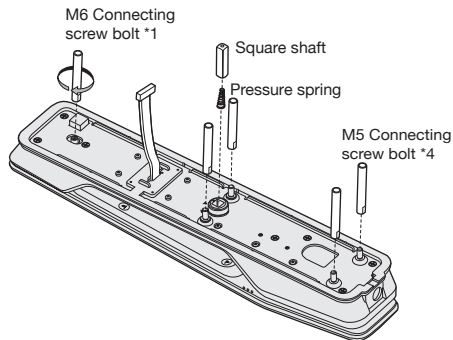

- CAUTION**
1. Spring: the big end is downward.
 2. Select the square shafts and screw bolts with proper length according to door thickness range.

3. Pass the connection wire through the top bore. Then align and insert square shaft into mortise holes to make the front panel against the door closely.

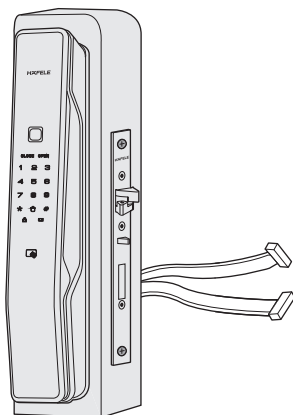

4. Install the mounting plate with fixing screws tightly against the door surface.

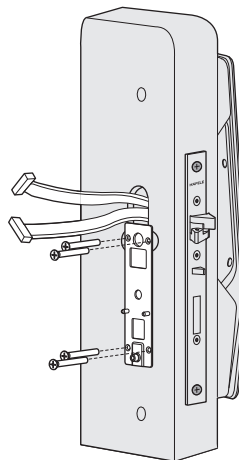

✓ Installation

5. Place pressure spring and square shaft in the back panel in proper order.

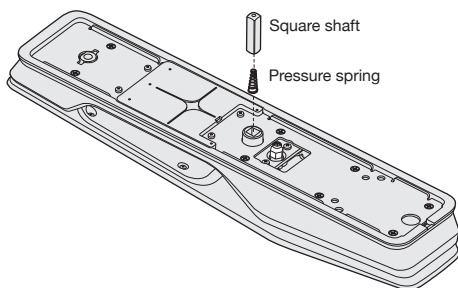

6. Insert the connecting wires of front panel into the related sockets of the back panel. Then align and insert the square shaft into mortise hole, make the back panel against the door closely. Finally tighten the 2 fixing screws.

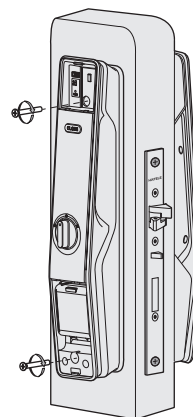

7. Install the batteries, the battery cover and the upper cover. Then install the striker assembly to finish installation.

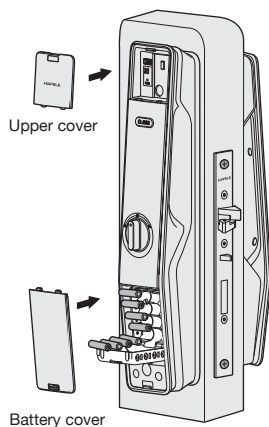

8. please check push-pull handle and mechanical key if they are working properly.



⚠ CAUTION

After installing the striker assembly, please check if the lock works smoothly by opening/closing door.

⚠ CAUTION

Test if mechanical key works smoothly after installation.